

Quick Guide

LSM 700

Laser Scanning Microscope



LSM Software ZEN 2009

April 2009



We make it visible.

Contents

	Page
Contents	1
Introduction.....	1
Starting the System	2
Introduction to ZEN – Efficient Navigation	5
Setting up the microscope.....	10
Configuring the beam path and lasers.....	13
Scanning an image.....	18
Storing and exporting image data	23
Switching off the system.....	24

Introduction

This LSM 700 Quick Guide describes the basic operation of the LSM 700 Laser Scanning Microscope with the ZEN 2009 software.

The purpose of this document is to guide the user to get started with the system as quick as possible in order to obtain some first images from his samples.

This Quick Guide does NOT replace the detailed information available in the full user manual or in the manual of the respective microscopes (Axio Imager, Axio Observer).

Also, this Quick Guide is written for a user who is familiar with the basics of Laser Scanning Microscopy.



For your safety!
Observe the following instructions:

- The LSM 700 laser scanning microscope, including its original accessories and compatible accessories from other manufacturers, may only be used for the purposes and microscopy techniques described in this manual (intended use).
- In the Operating Manual, read the chapter *Safety Instructions* carefully before starting operation.
- Follow the safety instructions described in the Operating Manual of the microscope and X-Cite 120 lamp / HBO 100 mercury lamp.

Starting the System

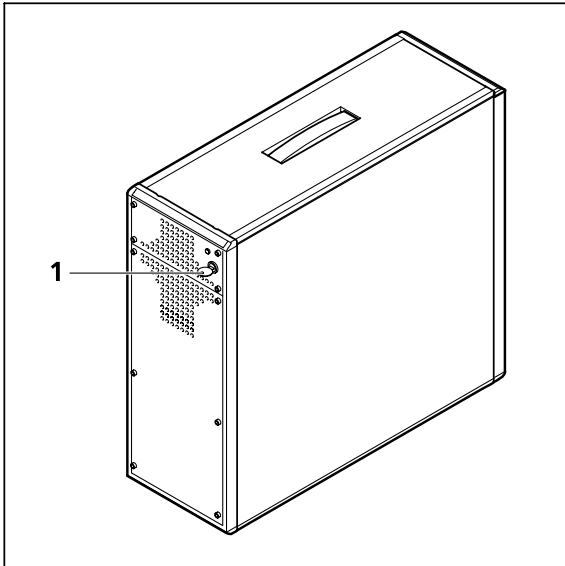

Fig. 1 Electronics and laser module

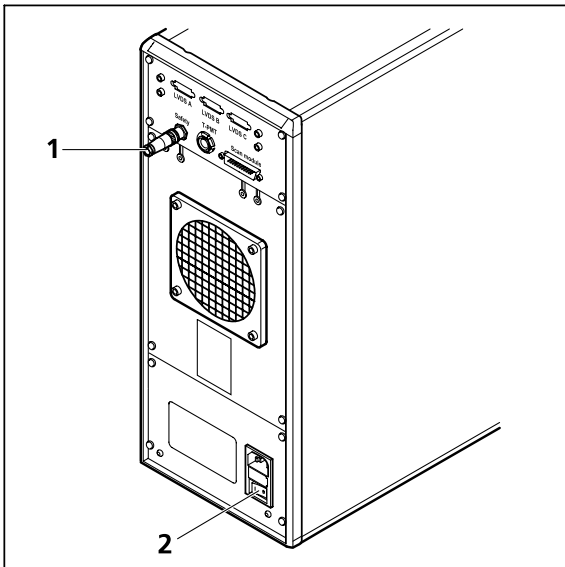

Fig. 2 Electronics and laser module

Switching on the LSM 700 system

- Turn on the LSM 700 system via the switch-operated multipoint connectors (power strips 1 and 2) on the system. This switches on all system components except attached scanning stages, the microscope and its illumination (HBO 100, XBO 75 or HXP 120).
- If using the Axio Observer microscope stand, push the power button at the left hand side first to switch on the microscope.
- Turn the key switch (Fig. 1/1) of the electronics and laser module to the right to start the laser. The yellow LED in return turns on. If this is not the case, check the power switch (Fig. 2/2) on the back of the laser module.
- On the back of the system there is a plastic screw (Fig. 2/1). This is a laser interlock which can be used for coupling the laser module e.g. to doors. If this screw is **unscrewed** the lasers will **not** turn on!

Switching on the HXP 120 or the HBO 100 or the XBO 75 lamps

- Switch on the main switch of the HXP 120 / HBO 100 / XBO 75 lamps for reflected light illumination via the power supply as described in the respective operating manual.

Switching on the scanning stage

- If attached, switch on the scanning stage via the controller.

Starting the ZEN software



- Double click the **ZEN 2009** icon on the WINDOWS desktop to start the Carl Zeiss LSM software.

The **ZEN Main Application** window and the **LSM 700 Startup** window appear on the screen (Fig. 3).

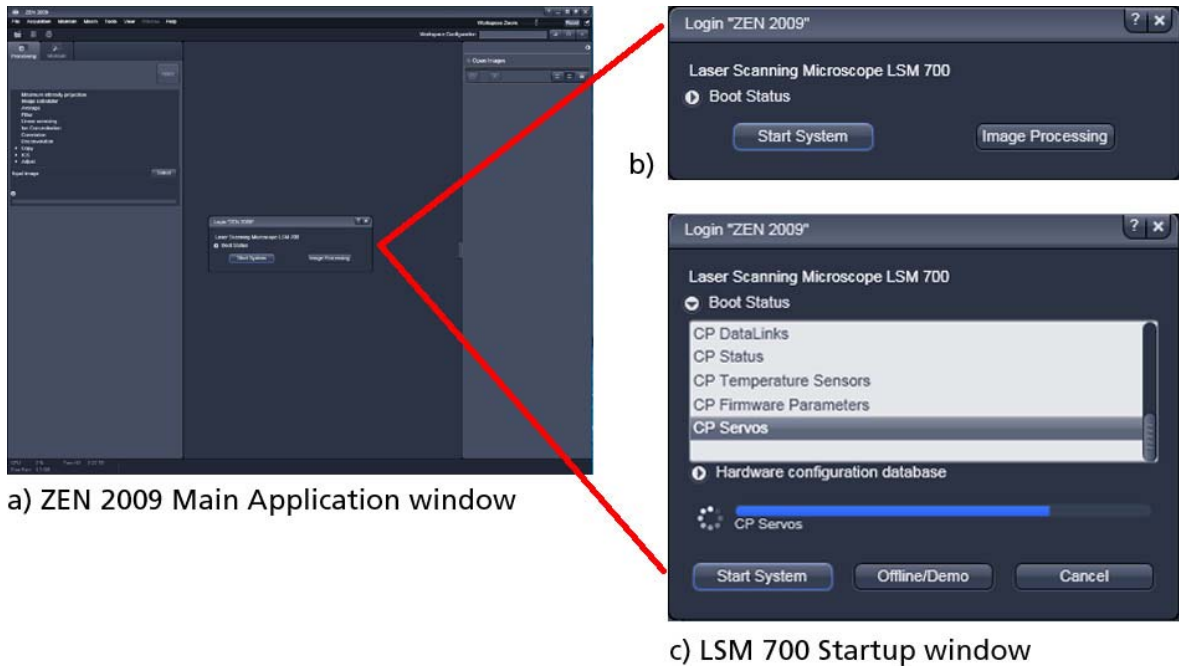



Fig. 3 ZEN Main Application window at Startup (a) and the LSM 700 Startup window (b and c)

In the small startup window, choose either to start the system online (**Start System** hardware for acquiring new images) or in **Image Processing** mode to edit already existing images. Toggle the little  symbol to view the Boot Status display and get the additional **Offline/Demo** button option:

- Choosing **Start System** initializes the whole microscope system and activates the entire software package for new image acquisition and analysis.
- The **Image Processing** mode ignores all hardware and activates only data handling and image processing functionality for already acquired images.
- The **Offline/Demo** mode reads the current hardware database but does not activate the system hardware for use. Instead, it simulates the system hardware for training purposes.
- Upon clicking the **Start System** button, the **Image Processing** button changes to a **Cancel** button. Click **Cancel** to interrupt/stop **Startup** of the system.

After startup, the ZEN Main Application window (Fig. 4 and Fig. 5) opens. To benefit from all of ZEN's features, run the window in its full screen mode.

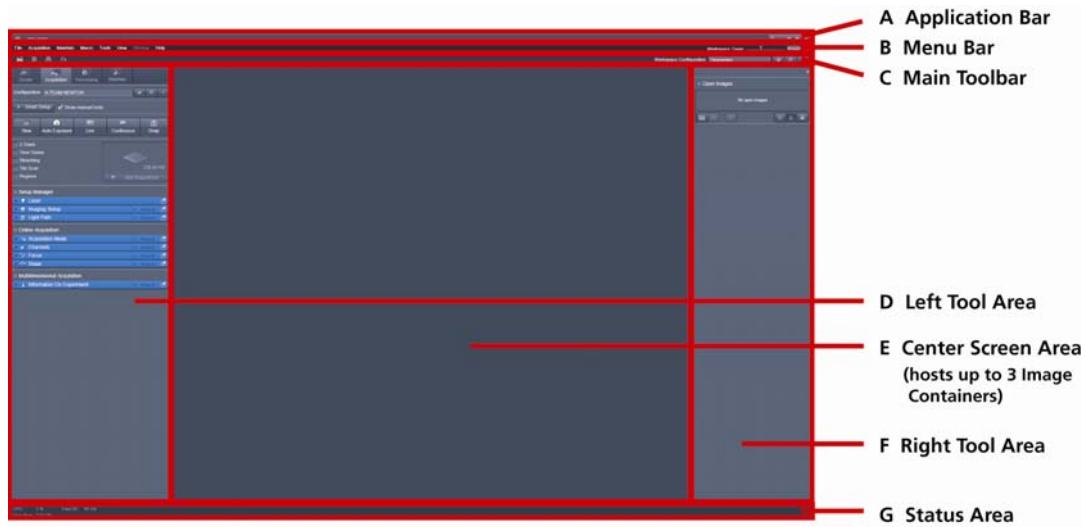
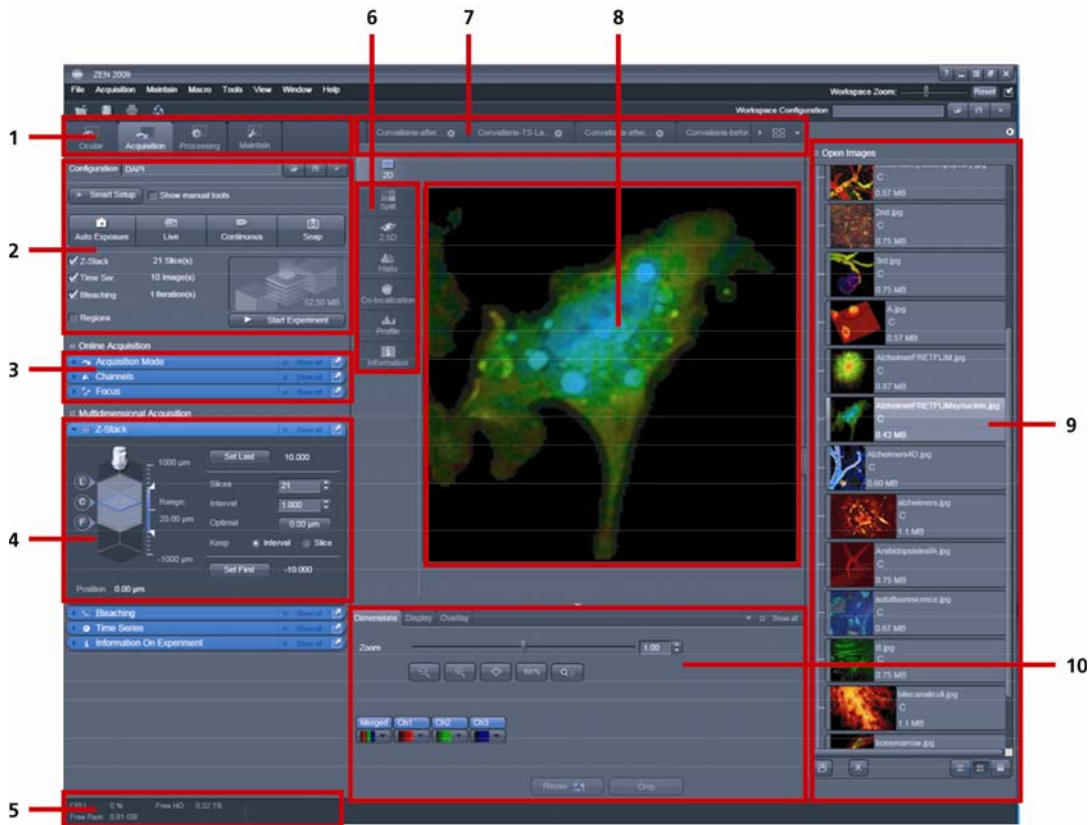

Fig. 4 ZEN Main Application window after startup with empty image container



- | | |
|---|----------------------|
| 1 Tabs to switch between the tool types | 6 View tabs |
| 2 Start buttons | 7 Image tabs |
| 3 Tool group | 8 Displayed image |
| 4 Tool | 9 File handling area |
| 5 Status bar | 10 View controls |

Fig. 5 ZEN Main Application window after startup with several images loaded

Introduction to ZEN – Efficient Navigation

The **ZEN 2009** Interface is clearly structured and follows the typical workflow of the experiments performed with confocal microscopy systems:

On the **Left Tool Area** (Fig. 4/D) the user finds the tools for sample observation, image acquisition, image processing and system maintenance, easily accessible via four **Main Tabs** (Fig. 5/1). All functions needed to control the microscope can be found on the **Ocular** tab, to acquire images use the **Acquisition Tools** (Fig. 5/3 and 4). Arranged from top to bottom they follow the logic of the experimental workflow. The area for viewing and interacting with images is centered in the middle of the **Main Application** window: the **Center Screen Area**. Each displayed image can be displayed and/or analyzed with many view options available through view tabs which can be found on the left side of the image. According to the chosen view tab, the required view controls appear in View Control Tabs below each image. File management and data handling tools are found in the **Right Tool Area** (see Fig. 4 and Fig. 5).

Color and brightness of the interface have been carefully adjusted to the typical light conditions of the imaging laboratory, guaranteeing optimal display contrast and minimal stray light for high-sensitivity detection experiments. The **ZEN** software is optimized for a 30" TFT monitor but can also be used with dual-20" TFT setups.

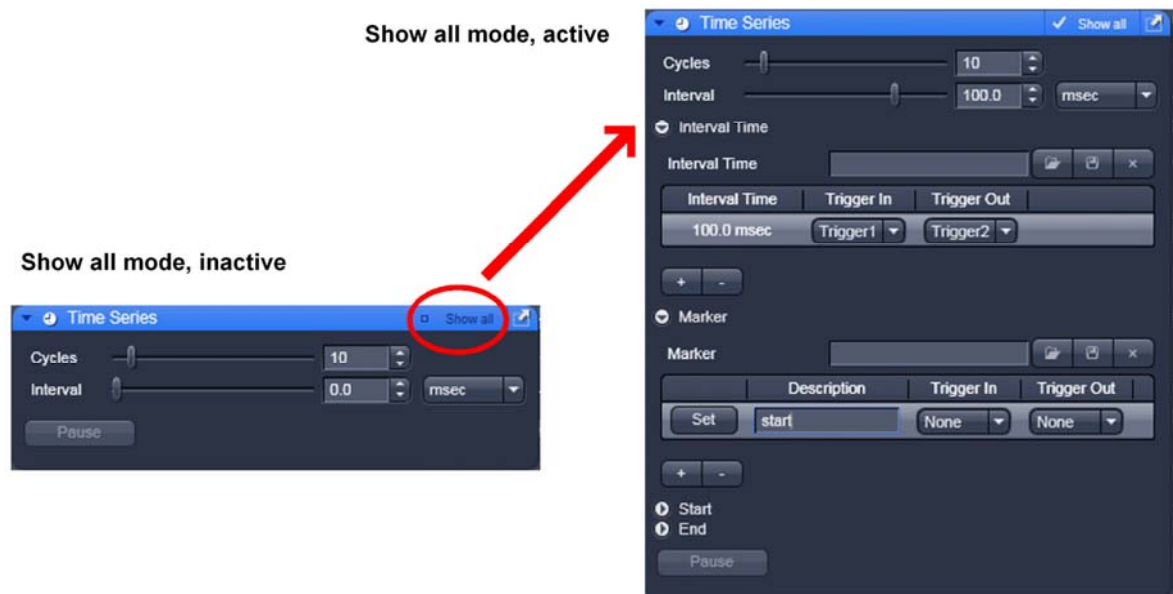

Fig. 6 Show all mode

A focus in the development of **ZEN 2009** was to fulfill the needs of both basic users and microscopy specialists. Both types of users will appreciate the set of intuitive tools designed to make the use of a confocal microscope from Carl Zeiss easy and fast.

The **Show all** concept ensures that tool panels are never more complex than needed. With **Show all** deactivated, the most commonly used tools are displayed. For each tool, the user can activate **Show all mode** to display and use additional functionality (Fig. 6).

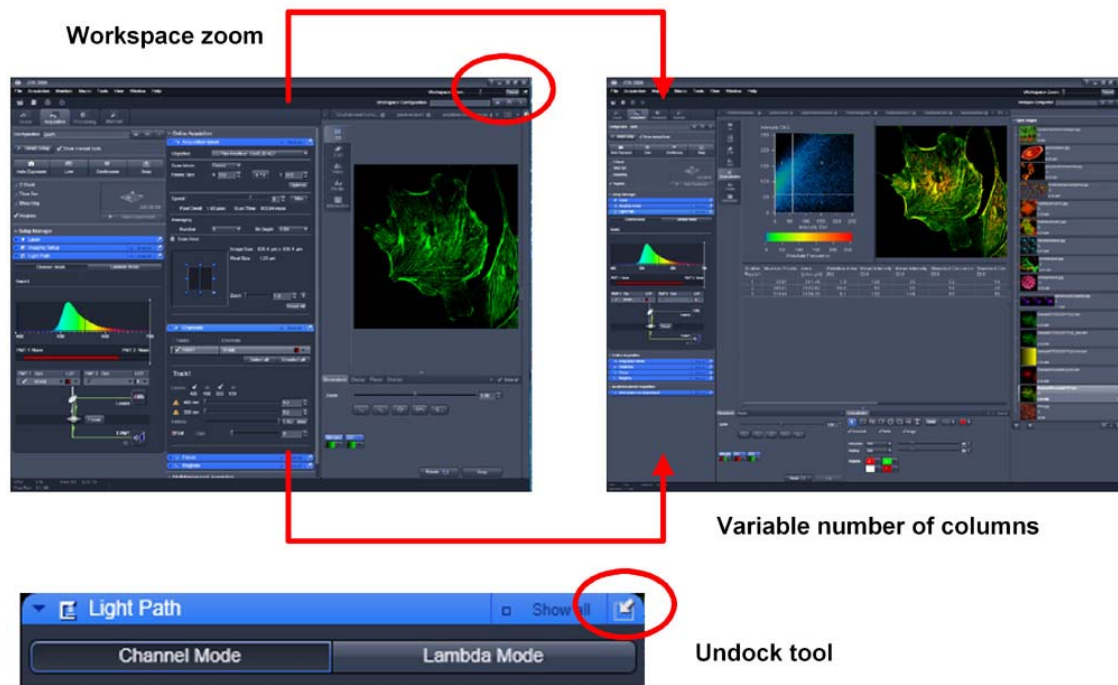





Fig. 7 ZEN Window Layout configuration

More features of **ZEN 2009** include:

- The user can add more columns for tools to the **Left Tool Area** or detach individual tools to position them anywhere on the monitor. To add a column, drag a tool group by the title bar (e.g., Online Acquisition) to the right and a new tool column automatically opens. Alternatively use the context menu "move toolgroup to next column". To detach a tool, click on the little icon on the very right end of the blue tool header bar (Fig. 7).
- Another unique feature in Imaging software is the scalable ZEN interface. This **Workspace Zoom** allows adjustment of the **ZEN 2009** window size and fonts to the situational needs or your personal preferences (Fig. 7).
- Setting up conventional confocal software for a specific experiment can take a long time and is often tedious to repeat. With ZEN these adjustments have to be done only once – and may be restored with just two clicks of the mouse. For each type of experiment one can now set-up and save the suitable **Workspace Layout**. These configurations can also be shared between users.
- For most controls, buttons and sliders, a **tool tip** is available. When the mouse pointer is kept over the button, a small pop-up window will display which function is covered by this tool/button.

These are just some of the most important features of the ZEN interface. For a more detailed description of the functionality for the **ZEN 2009** software, please refer to the User Manual that is provided with your system.

Setting up a new image document and saving your data

To create a new image document in an empty image container, click the **Snap**  or the **Auto Exposure**  button. For an empty image document press the **New**  button.

The new document is immediately presented in the **Open Images Area**. Remember, an unsaved 2D image in the active image tab will be over-written by a new scan. Multi-dimensional scans or saved images will never be over-written and a new scan will then automatically create a new image document.

Acquired data is **not** automatically saved to disc. Make sure you save your data appropriately and back it up regularly. The ZEN software will ask you if you want to save your unsaved images in case you try to close the application with unsaved images still open.

 There is no image database any more like in the earlier Zeiss LSM software versions.

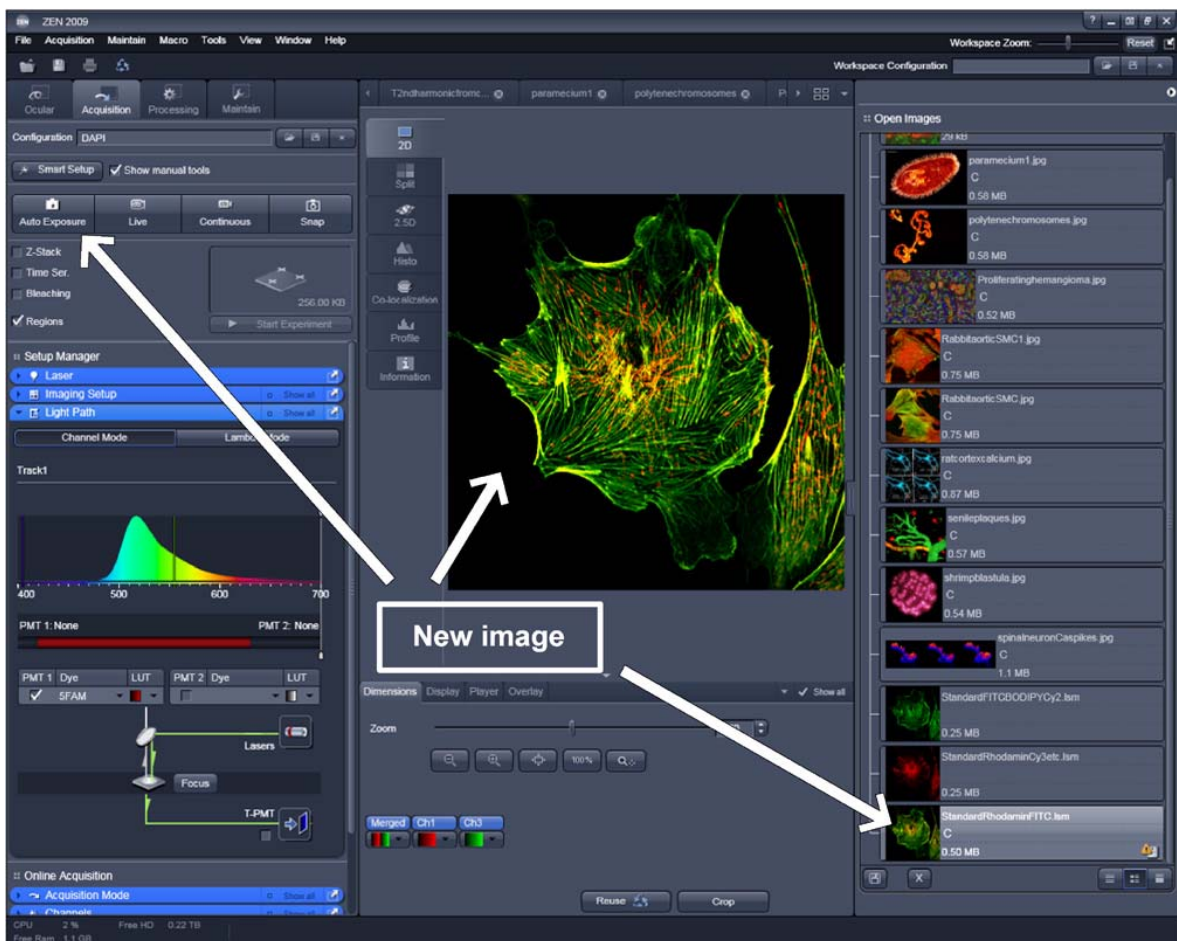

Fig. 8 New image document in the Open Images Areas

Advanced data browsing is available through the **ZEN File Browser** (Ctrl + F or from the **File** menu). The File Browser can be used like the WINDOWS program file browser. Images can be opened by double-click and image acquisition parameters are displayed with the thumbnails (Fig. 9). For more information on data browsing please refer to the detailed operating manual.

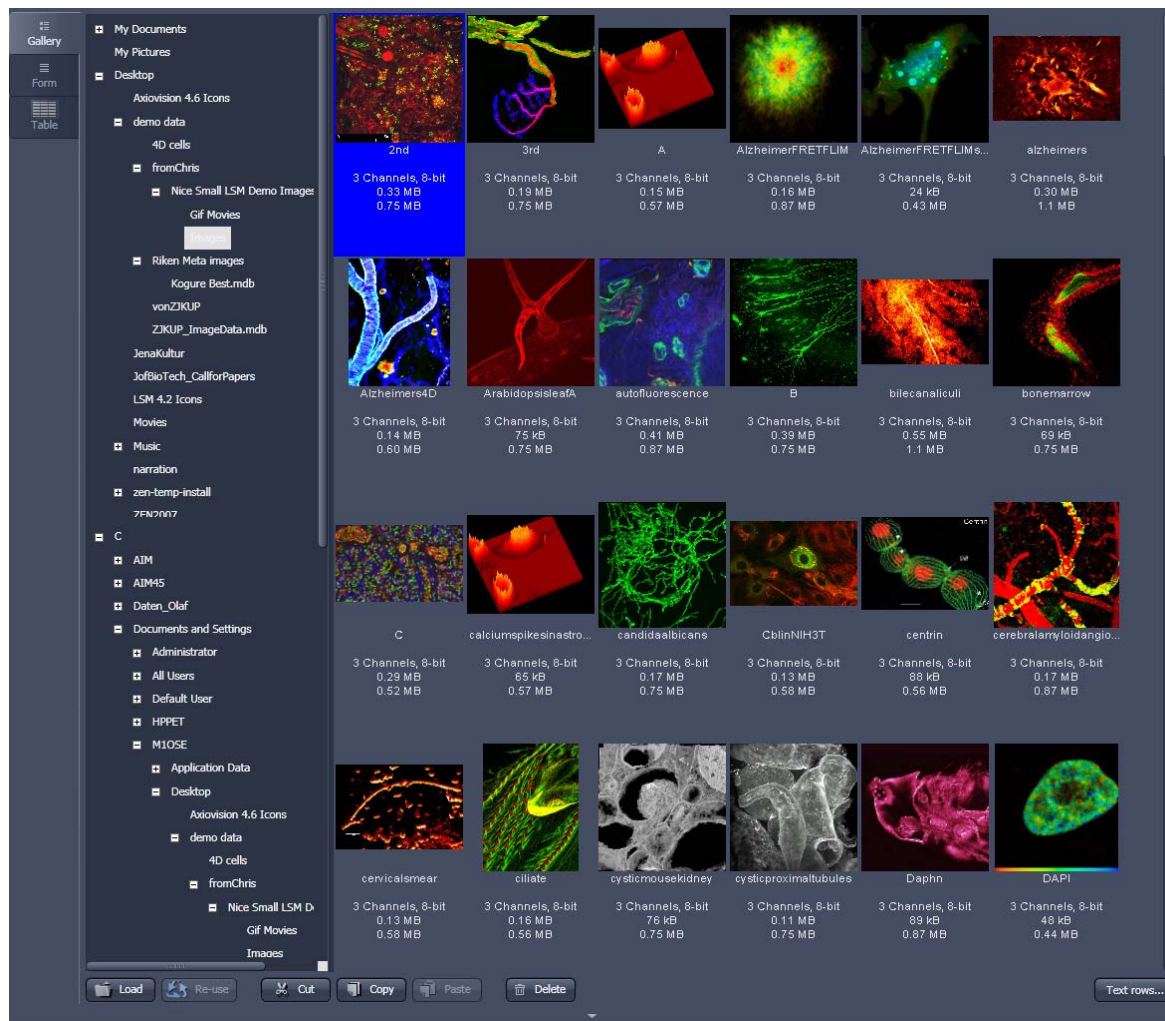

Fig. 9 File Browser

Turning on the lasers

ZEN 2009 operates all lasers automatically. Whenever they are used (manually or by the **Smart Setup** function) the lasers are turned on automatically. The **Laser Life Extender** function of the software shuts all lasers off if ZEN is not used for more than 15 minutes.

- To manually switch lasers on or off, click the **Show manual tools** tick box and open the **Laser** tool. All available lasers can be operated within this tool (Fig. 10).

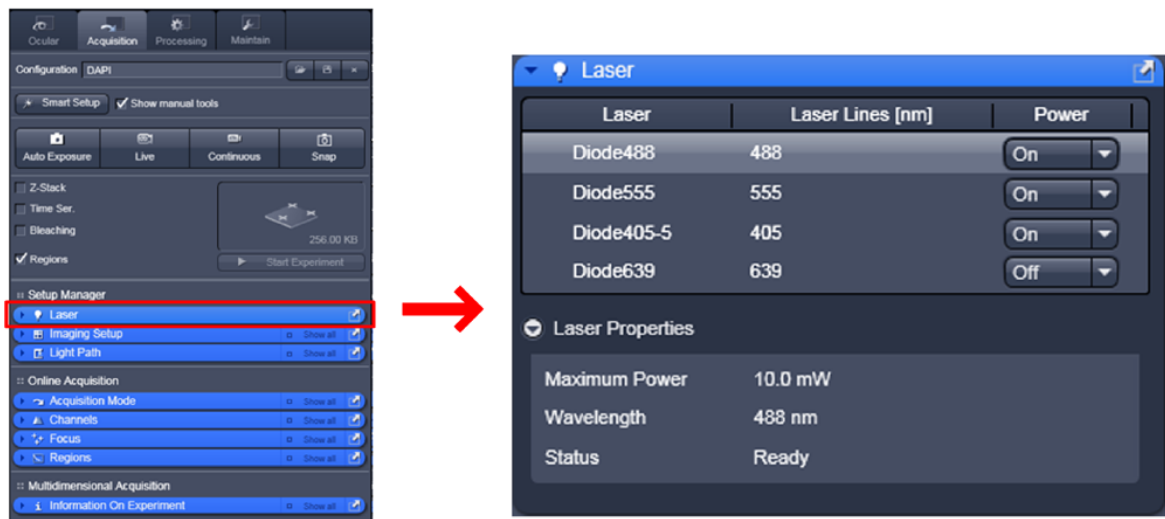

Fig. 10 Laser Control tool

Setting up the microscope

Changing between direct observation and laser scanning mode

On the **Ocular** tab, the basic switch between manual operation of the microscope (observation of the specimen with the eye) and laser scanning mode is located.



- Click on the **Ocular** tab to access the microscope controls. Pressing the **Online** button sets the Ocular tool active – the specimen can be observed and all changes in the ocular tool take effect immediately. When pressing the **Offline** button the system stays in the imaging mode. Changes in the ocular tool do only take effect once the **Ocular** tab is set in the active mode (**Online**) again. When leaving the **Ocular** tab the software remembers the state of the **Online/Offline** buttons.



- Click on the **Acquisition** tab to start imaging (laser scanning mode). After pressing one of the start buttons the system automatically switches laser scanning mode.

Setting up the microscope and storing settings

Click on the **Ocular** tab for direct observation; press the **Online** button for your actions to take effect immediately. Then open the **Ocular** tool to configure the components of your microscope like filters, shutters or objectives (Fig. 11).

Selecting an objective

- Open the graphical pop-up menu by clicking on the **Objective** symbol and select the objective lens for your experiment (Fig. 11).
 - The chosen objective lens will automatically move into the beam path.

Focusing the microscope for transmitted light

- Open the graphical pop-up menu by clicking on the **Transmitted Light** icon (Fig. 12).
- Click on the **On** button. Set the intensity of the Halogen lamp using the slider.
- Clicking outside the pop-up control closes it.
- Place specimen on microscope stage. The cover slip must be facing the objective lens. Remember the immersion medium if the objective chosen requires it!
- Use the focusing drive of the microscope to focus the object plane.
- Select specimen detail by moving the stage in X and Y using the XY stage fine motion control.

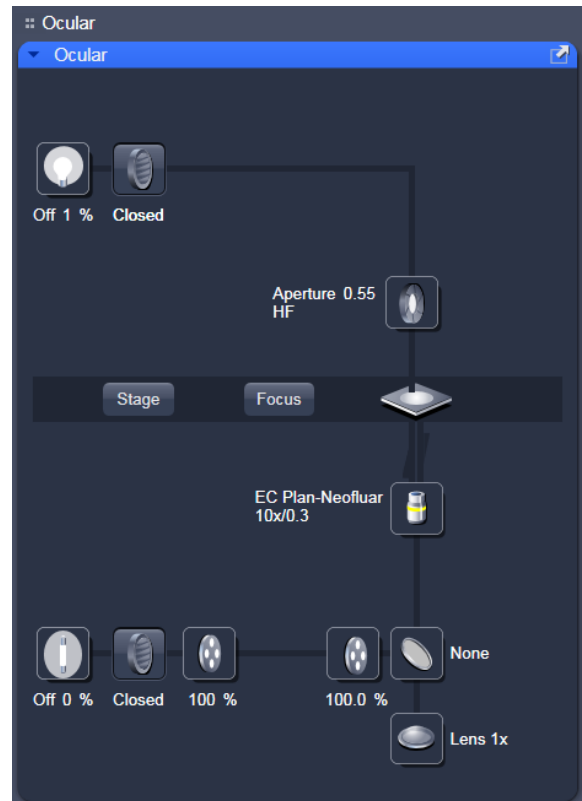

Fig. 11 Microscope Control window, e.g.: Axio Observer

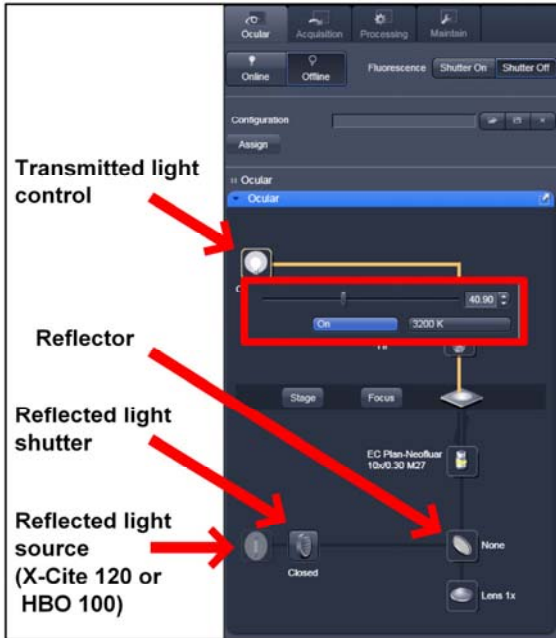



Fig. 12 Microscope Control window with Transmitted Light pop-up menu

Setting the microscope for reflected light

- Click on the **Reflected light source** icon to open the X-Cite 120 controls and turn it on.
- Click on the **Reflected light shutter** to open the shutter of the X-Cite 120 lamp / HBO100.
- Click on the **Reflector** button and select the desired filter set by clicking on it.

Storing the microscope settings

Microscope settings can be stored as configurations (Fig. 13) by pressing the save button  and typing a configuration name in the pop-up window – confirm the name by clicking **OK**. Fast restoration of a saved configuration is achieved by selecting the configuration from the pull-down list. The configuration is then immediately loaded and possible hardware changes are performed. Configurations can be selected from a pull down list and deleted by pressing the delete  button.

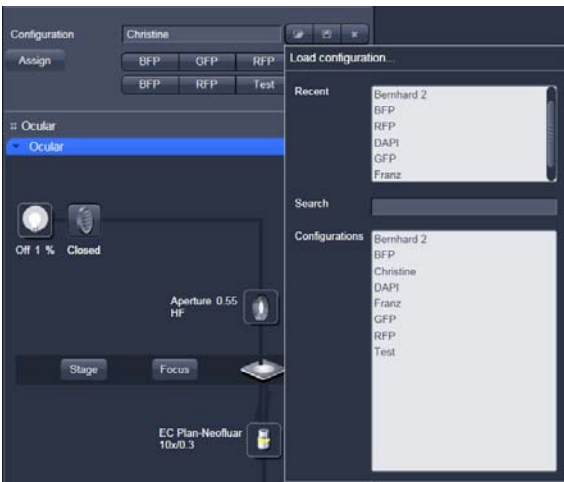

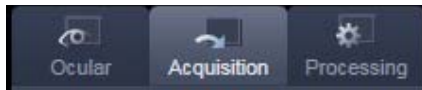

Fig. 13 Saving and loading Microscope configurations

These configurations can be assigned to buttons that are easier to press.

-  Depending on the microscope configuration, the settings must be done manually if necessary.

Configuring the beam path and lasers



- Click the **Acquisition** button.

Smart Setup

The tool **Smart Setup** is an intuitive, user-friendly interface which can be used for almost all standard applications. It configures all the system hardware for a chosen set of dyes.

- Click on the **Smart Setup** button  to open the smart setup window. This window can be accessed any time from the software to change dye combinations.
- Click on the arrow in the dye list and simply choose the dye(s) you want to use in your experiment from the list dialogue. In this dialogue, the dyes can be also searched by typing the name in the search field.

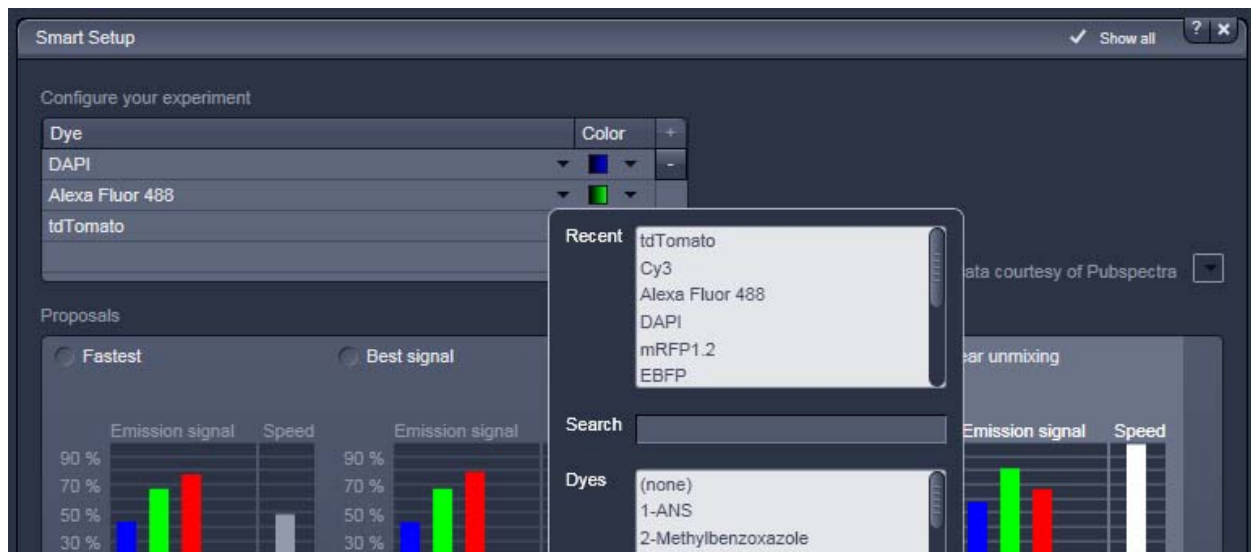

Fig. 14 Smart Setup tool

Once finished with the input, **Smart Setup** suggests four alternative considerations (see below): One for **Fastest** imaging, one for the **Best signal**, **Best compromise** between both speed and best signal and the optimal setup for later **Linear unmixing** of the dyes.

The graphs display relative values for the expected emission signals and cross-talk. The resulting imaging scheme (single or multitrack) is shown below the graphs.

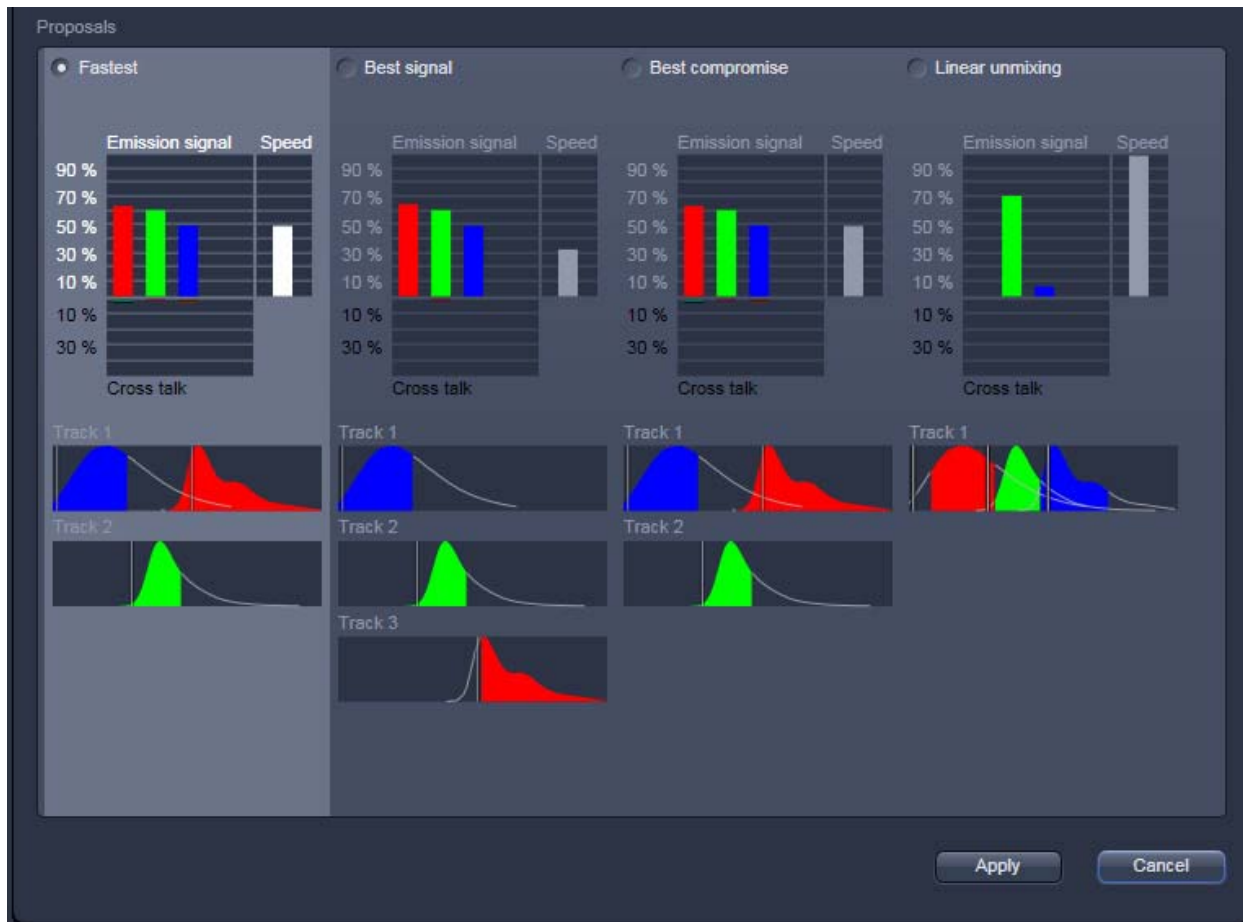
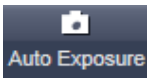

Fig. 15 Proposals panel of the Smart Setup tool

Pressing **Apply**, automatically sets the hardware parameters in the displayed way for the dyes chosen.

If the option **Linear Unmixing** is chosen, the system is set in the lambda mode automatically.

Pressing the **Auto Exposure**  button will then optimize the settings of the **Gain** for the given laser power and pinhole size. Further image optimization from this point can be done easily.

Setting up a configuration manually

For the manual setup of the system (without using the smart setup functionality) tick the **Show manual tools** Show manual tools tick box on top of the **Acquisition** tab. The tool group **Setup Manager** will appear containing the tools **Laser**, **Imaging Setup** and **Light Path**.

Simultaneous scanning of single, double, and triple labeling:

- Advantage: faster image acquisition
- Disadvantage: cross-talk between channels

Sequential scanning of double and triple labeling; line-by-line or frame-by-frame:

- Advantage: Only one detector and one laser are switched on at any one time. This reduces cross-talk.
- Disadvantage: slower image acquisition

- Open the **Imaging Setup** and the **Light Path** tool in the **Setup Manager** tool group to setup the imaging configuration. De-activate the **show all** mode.

The open **Light Path** is shown in Fig. 16.

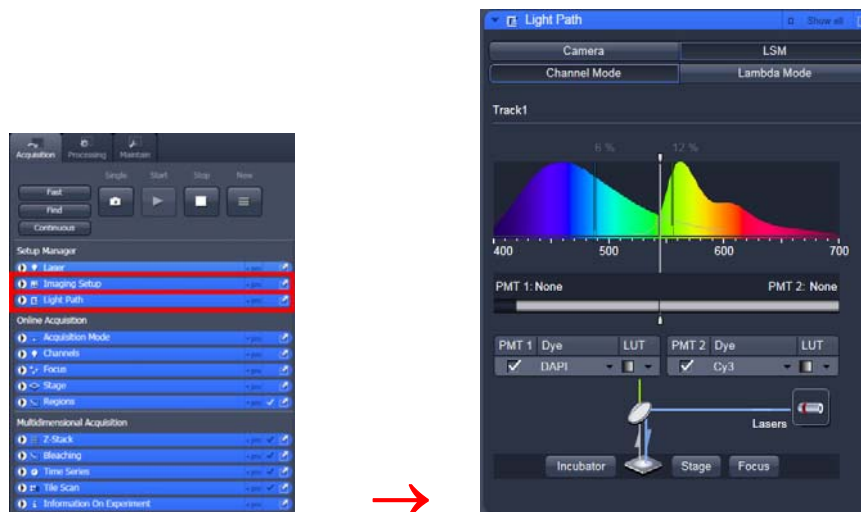

Fig. 16 Light Path tool for a single track (LSM 700)

Settings for track configuration in Channel Mode

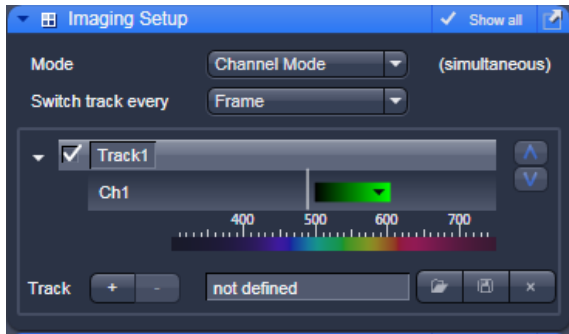

Fig. 17 Imaging Setup tool for a single track (LSM)

- Select **Channel Mode** if necessary (Fig. 17).
- Click on the **LSM** button in the light path tool (Fig. 16).

The **Light Path** tool displays the selected track configuration which is used for the scan procedure.

- You can change the settings of the light path tool using the following functional elements:



Activation / deactivation of the excitation wavelengths (check box) and setting of excitation intensities (slider). If necessary open the **Laser Control** tool (see above).

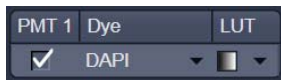

Activation / deactivation (via check box) of a channel (**PMT1, 2**), the dye to be detected with this channel (**dye**), and a color for display (**LUT**) of the acquired information.

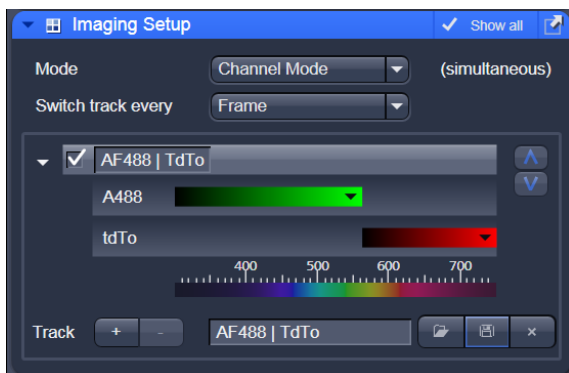





Fig. 18 Detection Bands & Laser Lines display

- The system will automatically: a) select the most appropriate position of the secondary dichroic mirror and b) choose the suitable emission filters for the dye combination entered for PMT 1 and PMT 2.
- The emission spectra and the laser lines used of the selected dyes are displayed in the light path tool.
- Click the **Laser** icon to select the laser lines and set the attenuation values (transmission in %) in the light path tool.
- In the **Imaging Setup** tool the Detection Bands & Laser Lines are also displayed in a spectral panel (Fig. 18) to visualize the activated laser lines for excitation (vertical lines) and activated detection channels (colored horizontal bars).

- For storing a new configuration click  and enter a desired name in the box (Fig. 19). Press **OK** to confirm.
- For loading an existing configuration click on  and select a configuration from the list box.
- For deleting an existing configuration click  and select it from the list box. Press **Ok** to confirm the deletion.

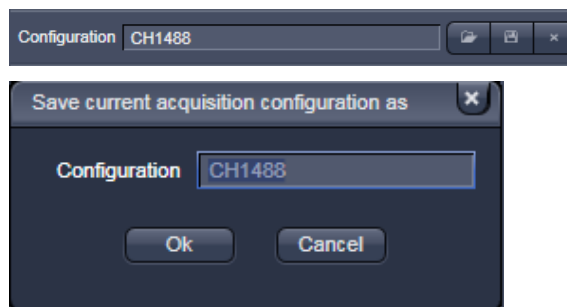

Fig. 19 Track Configurations window

Settings for multiple track configurations in Channel Mode

Multiple track set-ups for sequential scanning can be defined as one configuration (**Channel Mode Configuration**), to be stored under any name, reloaded or deleted.

The maximum of four tracks with up to three channels can be defined simultaneously and then scanned one after the other. Each track is a separate unit and can be configured independently from the other tracks with regard to channels, Acousto-Optical Tunable Filters (AOTF), emission filters and dichroic beam splitters.

The following functions are available in the **List of Tracks** panel in the **Imaging Setup** tool (Fig. 17, Fig. 18 and Fig. 19).

Switch track every

Line Tracks are switched during scanning line-by-line. The following settings can be changed between tracks: Laser line, laser intensity and channels.

Frame Tracks are switched during scanning frame-by-frame. The following settings can be changed between tracks: Laser line and intensity, all filters and beam splitters, the channels incl. settings for gain and offset and the pinhole position and diameter.

Frame Fast The scanning procedure can be made faster. Only the laser line intensity is switched, but no other hardware components. The tracks are all matched to the current track with regard to emission filter, dichroic beam splitter, setting of Detector Gain, pinhole position and diameter. When the **Line** button is selected, the same rules apply as for **Frame Fast**.



Add Track button

An additional track is added to the configuration list in the **Imaging Setup** tool. The maximum of four tracks can be used. One track each with basic configuration is added, i.e.: Ch 1 channel is activated, all laser lines are switched off, emission filters and dichroic beam splitters are set in accordance with the last configuration used.



Remove button

The track marked in the **List of Tracks** panel is deleted.



A click on this arrow button will move the selected track (highlighted in light grey) one position upwards in the list box.



A click on this arrow button will move the selected track (highlighted in light grey) one position downwards in the list box.

Scanning an image

Setting the parameters for scanning

- Select the **Acquisition Mode** tool from the **Left Tool Area** (Fig. 20).
- Select the **Frame Size** as predefined number of pixels or enter your own values (e.g. 300 x 600) in the **Acquisition Mode** tool. Click on the **Optimal** button for calculation of appropriate number of pixels depending on objective N.A. and λ .

The number of pixels influences the image resolution!

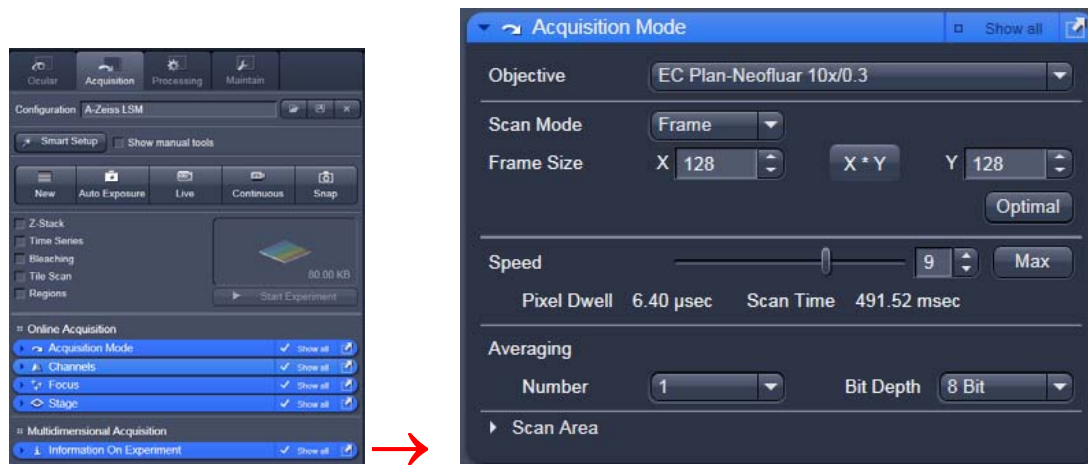

Fig. 20 Acquisition Mode tool

Adjusting scan speed

- Use the **Scan Speed** slider in the **Acquisition Mode** tool (Fig. 20) to adjust the scan speed.

A higher speed with averaging results in the best signal-to-noise ratio. Scan speed 8 usually produces good results. Use speed 6 or 7 for superior images.

Choosing the dynamic range

- Select the dynamic range 8 or 12 or 16 Bit (per pixel) in the **Bit Depth** pull-down in the **Acquisition Mode** tool (Fig. 20).

8 Bit will give 256 gray levels; 12 Bit will give 4096 gray levels, 16 Bit will give 65536 gray levels. Publication quality images should be acquired using 12 Bit data depth. 12 or 16 Bit is also recommended when doing quantitative measurements or when imaging low fluorescence intensities.

Setting scan averaging

Averaging improves the image by increasing the signal-to-noise ratio. Averaging scans can be carried out line-by-line or frame-by-frame. Frame averaging helps to reduce photo-bleaching, but does not give quite as smooth of an image.

- For averaging, select the **Line** or **Frame** mode in the **Acquisition Mode** tool.
- Select the number of lines or frames to average.

Adjusting pinhole

- Select the **Channels** tool in the **Left Tool Area**.
- Set the **Pinhole** size to **1 AU** (Airy unit) for best compromise between depth discrimination and detection efficiency.

Pinhole adjustment changes the **Optical Slice thickness**. When collecting multi-channel images, adjust the pinholes so, that each channel has the same **Optical Slice thickness**. This is important for colocalization studies.

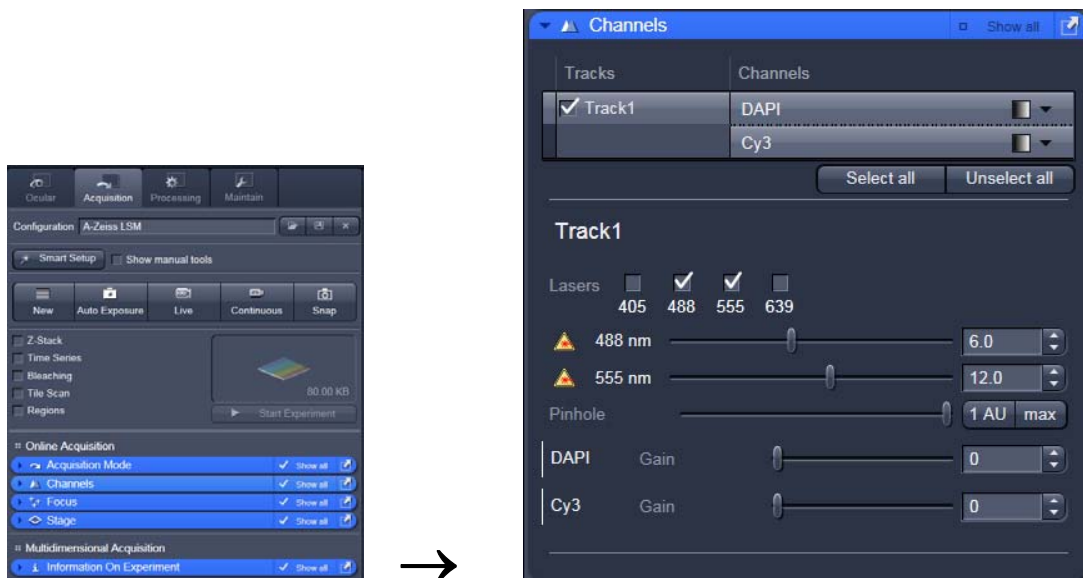
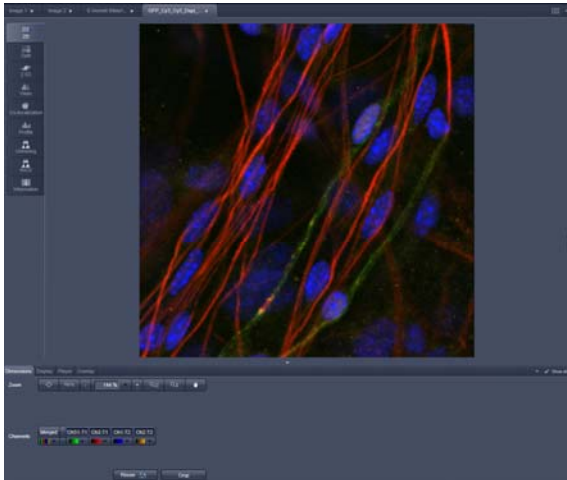

Fig. 21 Channels tool

Image acquisition



Once you have set up your parameter as defined in the above section, you can acquire a frame image of your specimen.

- Use one of the **AutoExposure**, **Live**, **Continuous** or **Snap** buttons to start the scanning procedure to acquire an image.
- Scanned images are shown in separate windows.
- Click on the **Stop** button to stop the current scan procedure if necessary.

Fig. 22 Image Display

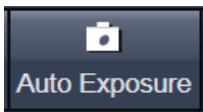

Select **AutoExposure** for automatic pre-adjustment of detector gain and offset.

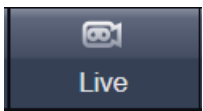

Select **Live** for continuous fast scanning – useful for finding and changing the focus.

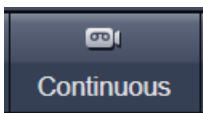

Select **Continuous** for continuous scanning with the selected scan speed.

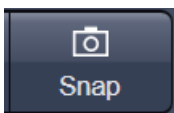

Select **Single** for recording a single image.

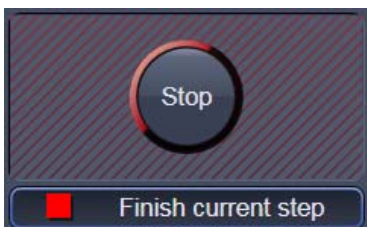



Select **Stop** for stopping the current scan procedure.

Image optimization

Choosing Range Indicator

- In the **View – Dimensions** View Option Control Tab, click inside the color field in the  button under the channel button (Fig. 23).

-  Clicking on the right hand side of the  button opens to a list of colors.

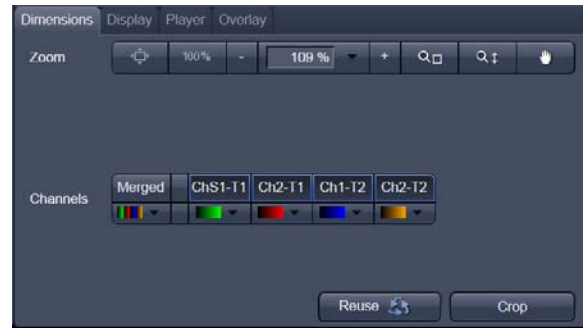

Fig. 23 View Dimensions Control Tab

The scanned image appears in a false-color presentation (Fig. 24).

If the image is too bright, it appears red on the screen. Red = saturation (maximum).

If the image is not bright enough, it appears blue on the screen. Blue = zero (minimum).

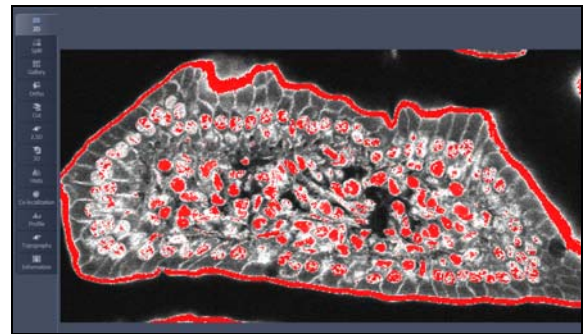

Fig. 24 Image Display

Adjusting the laser intensity

- Set the **Pinhole** to **1 AU** (Airy Unit) (Fig. 25).
- Set the **Gain** high.
- When the image is saturated, Laser Power in the **Laser** control section of the **Channels** tool (Fig. 25) using the slider to reduce the intensity of the laser light to the specimen.

Adjusting gain

- Reduce the **Gain** (Fig. 25) until the red pixels only just disappear.

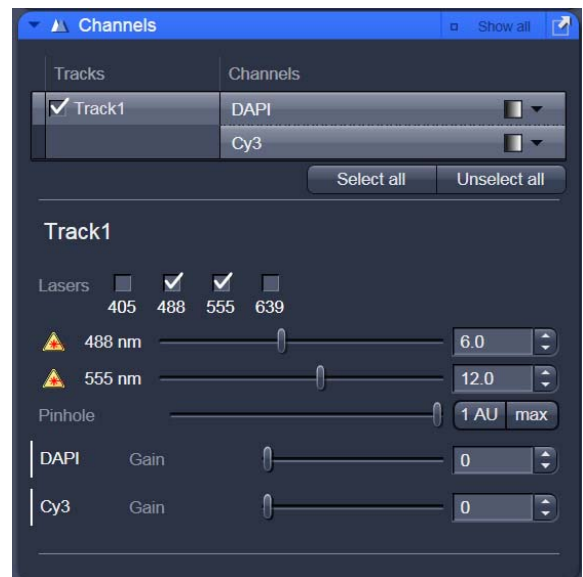

Fig. 25 Channels tool

Scanning a Z-Stack

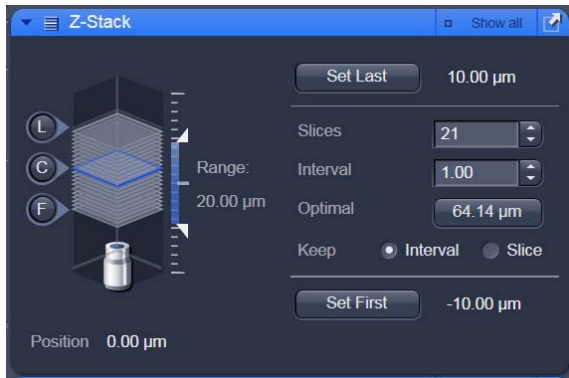



Fig. 26 Z Stack tool

- Select **Z-Stack** **Z-Stack** in the main tools area.
 - Open the **Z-Stack** tool in the **Left Tool Area**.
 - Click on the **Continuous** button in the **Action Button** area.
A continuous XY-scan of the set focus position will be performed.
 - Use the focus drive of the microscope to focus on the upper position of the specimen area where the Z-Stack is to start.
 - Click on the **Set First** button to set the upper position of the Z-Stack.
 - Then focus on the lower specimen area where the recording of the Z-Stack is to end.
 - Click on the **Set Last** button to set this lower position.
 - Click on the **Optimal** button to set number of slices to match the optimal Z-interval for the given stack size, objective lens, and the pinhole diameter.
 - Click on the **Start Experiment** **Start Experiment** button to start the recording of the Z-Stack.
-  When a multi-dimensional acquisition tool is not selected, the respective tool and its set parameters are not included in the multidimensional image acquisition. If no multidimensional tool is activated, the **Start Experiment** **Start Experiment** button is grayed out and only single images can be scanned.

Storing and exporting image data

- To save your acquired or processed images, click on the **Save** or **Save As** button in **File** menu, or click the  button in the **Main Toolbar** (Fig. 27/1), or click on the  button at the bottom of the **File Handling Area** (Fig. 27/2)

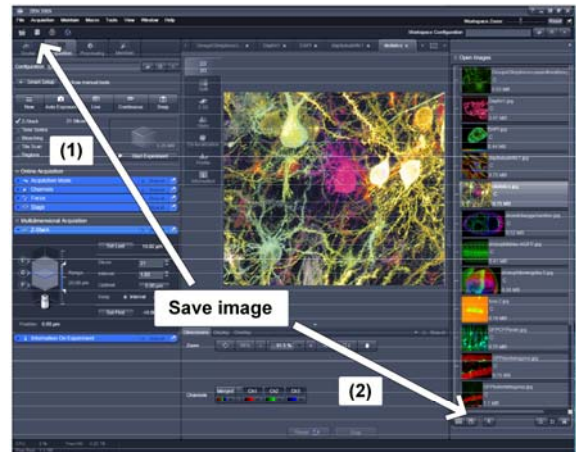

Fig. 27 Save Image buttons in ZEN

- The **WINDOWS Save As** window (Fig. 28) appears.
- Enter a file name and choose the appropriate image format.
Note: The LSM 5 format is the native Carl Zeiss LSM image data format and contains all available extra information and hardware settings of your experiment.
- Click on the **Save** button.

If you close an image which has not been saved, a pop-up window will ask you if you want to save it. Choosing **yes** will lead you to the **WINDOWS Save As** window.

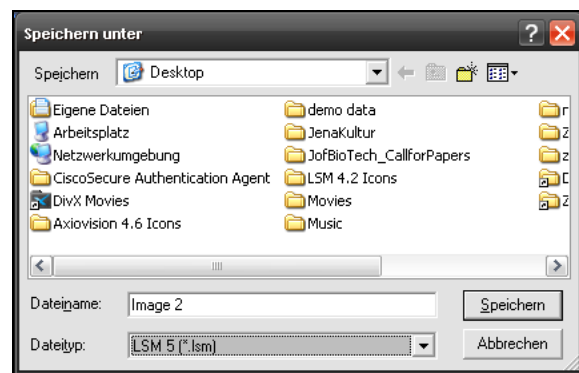

Fig. 28 Save as window

To export image display data, a single optical section in raw data format or the contents of the image display window including analysis and overlays, choose **Export** from the **File** menu. In the **Export** window you can select from a number of options and proceed to the **WINDOWS Save As** window to save the exported data to disk.

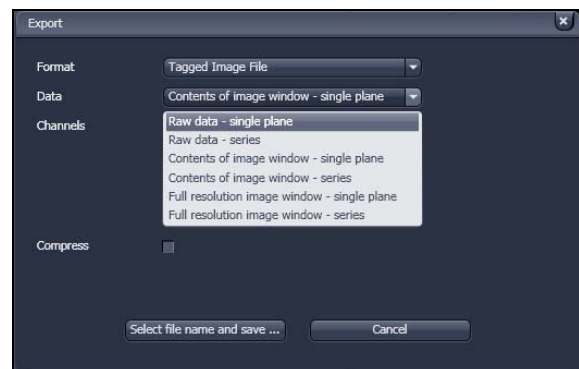

Fig. 29 Export window

Switching off the system

- Click on the **File** button in the **Main** menu bar and then click on the **Exit** button to leave the **ZEN 2009** software.
- Shut down the computer.
- Turn the key switch (Fig. 1/1) of the laser module to the left in the off position.
- If using the Axio Observer microscope stand, push the power button at the left hand side to switch off the microscope.
- Turn off the LSM 700 system via the switch-operated two multipoint connectors on the system.
- Switch off the HXP 120 / HBO 100 or XBO 75 lamps and, if necessary, the scanning stage and other attached components.

